

SONNTEK, INC.

System Selection Guide 2018/2019



AZURA® Systems

Collection of predefined systems

Made in Germany



Welcome to KNAUER - manufacturer of liquid chromatography instruments and solutions!

KNAUER ("KNAUER Wissenschaftliche Geräte GmbH") is an owner-managed middle-sized company situated in Berlin, Germany.

Since 1962, we have been developing, manufacturing and distributing laboratory instruments around the world. With more than 120 employees we are the oldest German manufacturer of instruments for HPLC, FPLC, simulated moving bed chromatography (SMB) and osmometry. Our product portfolio ranges from most compact analytical HPLC systems to SMB systems for the extraction of up to 1.000 kg of pure substance per year.

Products and services offered include state of the art HPLC/ UHPLC systems, FPLC systems, solutions for the purification of value products and fine chemicals, LC columns, and method development.

The source of our success are numerous world's firsts that have won more than 20 awards for innovation. We strive to grow continuously, to expand our expertises and to discover new market opportunities.



Alexandra Knauer (CEO and owner)

Quality and environmental management

The KNAUER quality management system according to DIN EN ISO 9001 makes sure that we continuously produce products in the best quality possible. As a company, we have to prove ourselves every day in a highly competitive market. Therefore, we can only be successful if every employee contributes his share. Your satisfaction with the quality of our products and services is the key to our success.

In addition to our quality management system, KNAUER contributes to the conservation of a healthy environment by basing our work on an environmental management system according to DIN EN ISO 14001.

Starting with the development of a new product, our designing engineers are bound to use long-lasting materials which allow low maintenance time intervals and minimal downtime. Furthermore, a high energy efficiency and material efficiency in the production

process and during the use of our products are important to us. Finally, the products should be able to be disposed of in an environmentally compatible way.

Every single part and original spare part corresponds to our strict criteria for construction, material and safety. This is guaranteed by our quality assurance system. And if your products need replacement or repair, it will be as good as a new with original spare parts from KNAUER.

The quality management system and the working procedures that come with it are being updated on a regular basis. All KNAUER employees know the procedures of the quality management system and its implementation. Continuous improvement is one of our goals and overall basic management principles.



KNAUER awards the international research prize "Humanity in Science Award"

Your remarks and suggestions are a substantial part of our daily work. They help us become even more precise, faster and more customer friendly. Please let us know what your suggestions are and what we can do better.

Please do not hesitate to contact our quality management team at quality@knauer.net!



AZURA® (U)HPLC Systems

AZURA® Educational System	1
AZURA® HPLC Compact iso (with UV detection)	2
AZURA® HPLC Compact iso (with UV and RI detection)	3
AZURA® HPLC Plus HPG/LPG (with UV detection)	4
AZURA® HPLC Plus HPG/LPG (with multichannel UV detection)	5
AZURA® UHPLC HPG/LPG (with multichannel UV detection)	6

AZURA® FPLC Systems

AZURA® Bio SEC 10	7
AZURA® Bio AC	8
AZURA® Bio Lab 10 LPG	9
AZURA® Bio Lab 10/50 HPG	10
AZURA® Bio Lab Plus	11
AZURA® Bio Pilot 100/250/500 LPG	12
AZURA® Bio Pilot 100/250/1000 HPG	13

AZURA® Preparative LC Systems

AZURA® Prep Compact 50 iso	14
AZURA® Prep Lab 50 HPG	15
AZURA® Prep Pilot 100/250/500 LPG	16
AZURA® Prep Pilot 100/250/500/1000 HPG	17
AZURA® Prep Pilot 100/250 HPG (with multicolumn auto-inject)	18

AZURA® Sample Preparation Systems

AZURA® GPC Cleanup	19
AZURA® Online SPE	20

System configurator

Analytical systems	21
Bio purification systems	22
Preparative systems	23

Conversion tables

Dimensions conversion chart	24
Temperature conversion chart	24
Pressure conversion chart	24
Tubing volume/Length conversion chart	24

Sketches

Notes

Order request

AZURA® Educational System

Isocratic analytical HPLC system with UV detection

The AZURA® Educational System is a small complete analytical isocratic HPLC system. Due to its compact dimensions, the system fits onto every laboratory bench.

The system is based on the multifunctional AZURA® Assistant ASM 2.1L and contains two integrated modules and a manual injection valve that is fixed to the side of the system. The integrated modules are a pump and an UV/VIS detector with one variable wavelength. A 10 mm flow cell is included in the package.

The system comes with an eluent tray for safe storage of up to 6 bottles. The column can be attached anywhere to the system via magnetic clip. A leak sensor and the tubing guide, as well as the Mobile Control with touch screen facilitate ensure a safe and user friendly usage.

Modern design with completely demountable fronts and exchangeable, optionally colored side panels turn the system into a visual highlight.

Key features

- Complete isocratic analytical HPLC system that needs very little bench space
- UV/VIS detector with one variable wavelength
- Pump unit with pressure sensor for a low pulsation eluent supply
- Mobile Control for maintenance
- Leakage protection
- Complete software package ClarityChrom® (Educational License)
- Notebook
- Capillary scheme
- Application note
- Introduction to operation of software and hardware via short movies

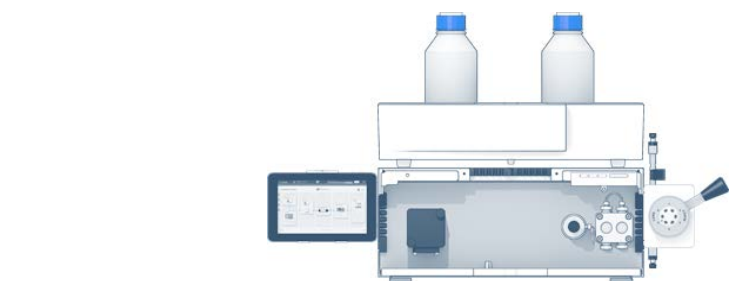

Ordering details:

A46002 Isocratic analytical HPLC system with UV detection and injection valve

AZURA® HPLC Compact iso (with UV detection)

Isocratic analytical HPLC system with UV detection

The AZURA® HPLC Compact iso is a small complete analytical isocratic HPLC system. Due to its compact dimensions, the system fits onto every laboratory bench.

The system is based on the multifunctional AZURA® Assistant ASM 2.1L and contains three integrated modules; an AZURA® Detector UVD 2.1S, an AZURA® Pump P 4.1S and an electric injection valve.

The system comes with an eluent tray for safe storage of up to 6 bottles. The column can be attached anywhere to the system via magnetic clip. A leak sensor and the tubing guidance as well as the Mobile Control unit with touch screen, facilitate ensure the safe and user friendly usage.

Modern design with completely demountable fronts turn the system into a visual highlight.

Key features

- Complete isocratic analytical HPLC system that needs very little bench space
- UV/VIS detector with one variable wavelength
- Pump unit with pressure sensor for a low pulsation eluent supply (max. 400 bar)
- Mobile Control for maintenance
- Leakage protection
- Complete software package ClarityChrom® (Educational License)
- RP analytical column kit, 3 columns (C8, C18, C18A)

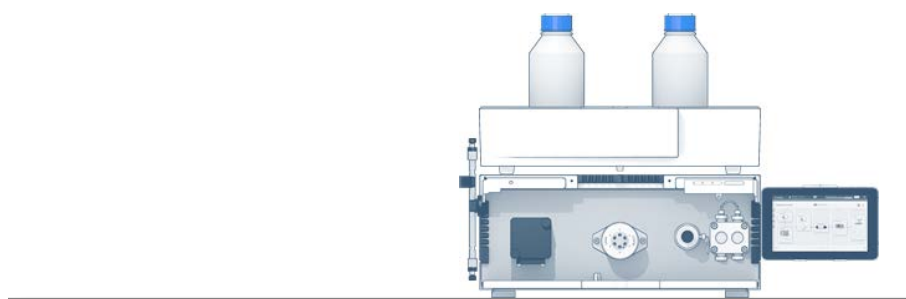

Ordering details:

A46003 Isocratic analytical HPLC system with UV detection and electric injection valve

AZURA® HPLC Compact iso (with UV and RI detection)

Isocratic analytical HPLC system with UV and RI detection

The AZURA® HPLC Compact iso is a small complete analytical isocratic HPLC system. Due to its compact dimensions, the system fits onto every laboratory bench.

The system is based on the multifunctional AZURA® Assistant ASM 2.1L and contains three integrated modules. An AZURA® Detector UVD 2.1S, an AZURA® Pump P 4.1S and an electric injection valve.

The system comes with an eluent tray for safe storage of up to 6 bottles. A leak sensor and the tubing guidance as well as the Mobile Control unit with touch screen, facilitate ensure the safe and user friendly usage.

Modern design with completely demountable fronts turn the system into a visual highlight.

The column thermostat AZURA® CT 2.1 is suitable for column thermostatisation above and below room temperature. The instrument operates with a microprocessor controlled Peltier element for exact temperature settings.

Key features

- Complete isocratic analytical HPLC system that needs very little bench space
- UV/VIS detector with one variable wavelength
- RI detection with temperature controlled optical bench
- Pump unit with pressure sensor for a low pulsation eluent supply (max. 400 bar)
- Mobile Control for maintenance
- PC with monitor and ClarityChrom® software
- Tubing scheme
- Leakage protection

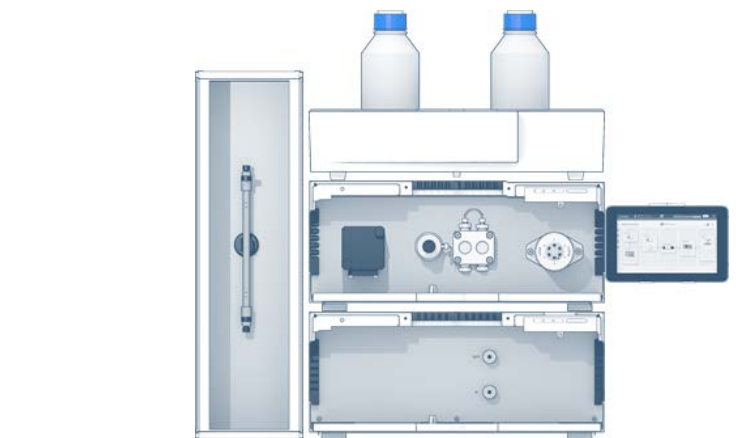

Ordering details:

A46004 Isocratic analytical HPLC system with UV / RI detection and electric injection valve

AZURA® HPLC Plus HPG/LPG (with UV detection)

Analytical HPG/LPG configuration with UV detection

This system features an AZURA® Pump P 6.1L HPG/LPG, an AZURA® Autosampler AS 6.1L, a column thermostat AZURA® CT 2.1, an AZURA® Detector UVD 2.1L with 1-variable UV measuring channels 90–750 nm, and a tablet with Mobile Control.

It is the standard system with a backpressure range of 700 bar. It perfectly fits the demanding needs of a method development system, as well as the robust fitness of a routine analysis machine.

The AZURA® Pump P 6.1L with a HPG configuration features a solvent selection valve to set up up to 4 solvents to the system of which two can be blended simultaneously.

The AZURA® Pump P 6.1L with a LPG configuration features a new LPG valve for the most precise blending efficiency. The internal degassing unit of the pump will prevent air bubbles in the system. Every pump comes with an attached mixing chamber, which can be changed to a larger volume depending on the applications needs.

The AZURA® Detector UVD 2.1L comes with an installed deuterium lamp which covers a wavelength range from 190 to 750 nm. It is a competitively priced HPLC for routine HPLC applications including fast LC methods.

The AZURA® Autosampler AS6.1L can inject 0.1–5000 µl to have a large flexibility. Using standard vials or two microtiter plates will give you a maximum sample capacity of up to 768 samples or 108 vials.

The column thermostat AZURA® CT 2.1 is suitable for column thermostatisation above and below room temperature. The instrument operates with a microprocessor controlled Peltier element for exact temperature settings.

Key features

- Complete gradient analytical HPLC system
- Variable single wavelength 1-channel UV/VIS detector
- Pump unit with pressure sensor for a low pulsation eluent supply (max. 700 bar)
- Mobile Control for maintenance
- Complete software package ClarityChrom®
- Leakage protection
- PC with Monitor
- Tubing scheme
- Application note

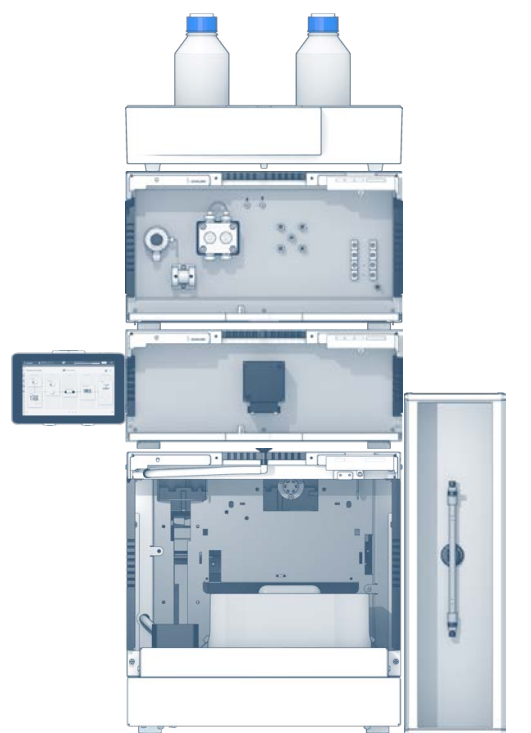

Ordering details:

A46006	Binary HPLC system with UVD 2.1L UV detector, autosampler, column thermostat and software
A46005	Quaternary HPLC system with UVD 2.1L UV detector, autosampler, column thermostat and software

AZURA® HPLC Plus HPG/LPG (with multichannel UV detection)

Analytical HPG/LPG configuration with multichannel UV detection

This system features an AZURA® Pump P 2.1L HPG/LPG, an AZURA® Autosampler AS 6.1L, a column thermostat AZURA® CT 2.1, an AZURA® Detector MWD 2.1L or DAD 2.1L with 8-variable UV measuring channels from 190 to 750 nm, and tablet with Mobile Control.

It is the standard system with a backpressure range of 700 bar. It perfectly fits the demanding needs of a method development system, as well as the robust fitness of a routine analysis machine.

The AZURA® Pump P 6.1L with a HPG configuration features a solvent selection valve to set up to 4 solvents to the system of which two can be blended simultaneously. The internal degassing unit will prevent air bubbles in the system. Every pump comes with an attached mixing chamber, which can be changed to a larger volume depending on the applications needs.

The AZURA® Pump with a LPG configuration features a new LPG valve for the most precise blending efficiency. The internal degassing unit will prevent air bubbles in the system. Every P 6.1L comes with an attached mixing chamber, which can be changed to a larger volume depending on the applications needs.

The AZURA® Detector DAD 2.1L features a novel light path and flow cell architecture with improved handling and excellent performance. The frontal lamp and cell change ensures easy and secure maintenance. The temperature controlled optical bench minimizes signal drift. The wide flow cell selection allows the DAD 2.1L to be easily adapted to your needs.

The AZURA® Autosampler AS 6.1L can inject 0.1-5000 µl to have a large flexibility. Using standard vials or two microtiter plates will give you a maximum sample capacity of up to 768 samples or 108 vials.

The column thermostat AZURA® CT 2.1 is the new price attractive basic column thermostat. It is suitable for column thermostatisation above and below room temperature. The instrument operates with a microprocessor controlled Peltier element for exact temperature settings.

Key features

- Complete gradient analytical HPLC system
- Variable multichannel UV/VIS detector (or DAD)
- Pump unit with pressure sensor for a low pulsation eluent supply (max. 700 bar)
- Mobile Control for maintenance
- Complete software package ClarityChrom®
- Leakage protection
- PC with monitor
- Tubing scheme
- Application note

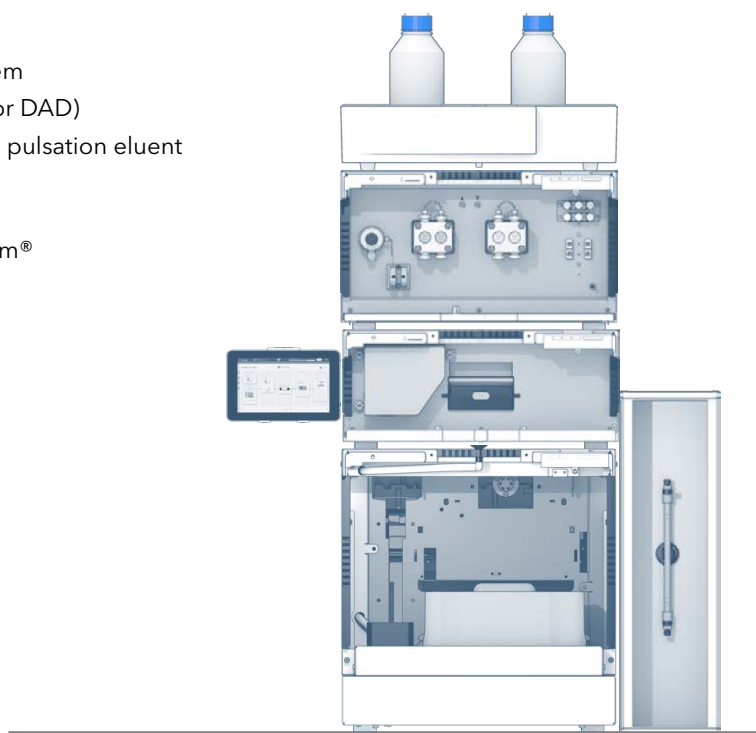

Ordering details:

A46007	Binary HPLC system with DAD 2.1L UV detector, autosampler, column thermostat and software
A46001	Quaternary HPLC system with DAD 2.1L UV detector, autosampler, column thermostat and software
A46008	Binary HPLC system with MWD 2.1L UV detector, autosampler, column thermostat and software
A46009	Quaternary HPLC system with MWD 2.1L UV detector, autosampler, column thermostat and software

AZURA® UHPLC HPG/LPG (with multichannel UV detection)

Analytical HPG/LPG configuration with multichannel UV detection

This system features an AZURA® Pump P 6.1L HPG/LPG, an AZURA® Autosampler AS 6.1L, a column thermostat AZURA® CT 2.1, an AZURA® Detector DAD 2.1L or DAD 6.1L UV/VIS detector with 8-variable UV measuring channels from 190–750 nm (190–1000 nm with DAD 6.1L), and a tablet with Mobile Control.

It is the UHPLC system with a backpressure range of 1000 bar. It perfectly fits the demanding needs of a method development system, as well as the robust fitness of a routine analysis machine.

The AZURA® Pump P 6.1L with a HPG configuration features a solvent selection valve to set up to 4 solvents to the system of which two can be blended simultaneously. The internal degassing unit will prevent air bubbles in the system. Every pump comes with an attached mixing chamber, which can be changed to a larger volume depending on the applications needs.

The AZURA® Pump P 6.1L with a LPG configuration features a new LPG valve for the most precise blending efficiency. The internal degassing unit will prevent air bubbles in the system. Every pump comes with an attached mixing chamber, which can be changed to a larger volume depending on the applications needs.

The AZURA® Detector DAD 6.1L features a novel light path and flow cell architecture with improved handling and excellent performance. The frontal lamp and cell change ensures easy and secure maintenance. The temperature controlled optical bench minimizes signal drift. The wide flow cell selection allows the detector to be easily adapted to your needs.

The AZURA® Autosampler AS 6.1L can inject 0.1–5000 µl to have a large flexibility. Using standard vials or two microtiter plates will give you a maximum sample capacity of up to 768 samples or 108 vials.

The column thermostat AZURA® CT 2.1 is the new price attractive basic column thermostat. It is suitable for column thermostating above and below room temperature. The instrument operates with a microprocessor controlled Peltier element for exact temperature settings.

Key features

- Complete gradient analytical HPLC system
- Variable multichannel UV/VIS detector (or DAD)
- Pump unit with pressure sensor for a low pulsation eluent supply (max. 1000 bar)
- Mobile Control for maintenance
- Complete software package ClarityChrom® or OpenLAB®
- Leakage protection
- PC with monitor
- Capillary scheme
- Application note

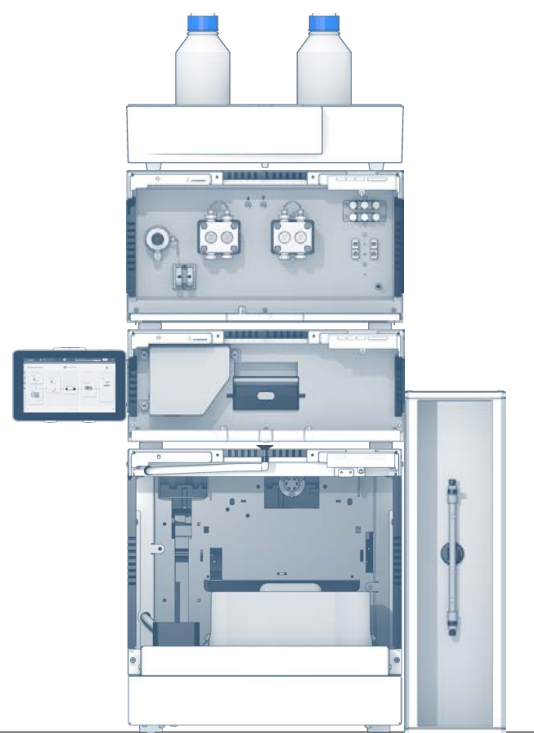

Ordering details:

A460010	Binary UHPLC system with DAD 2.1L UV detector, autosampler, column thermostat and software
A460011	Quaternary UHPLC system with DAD 2.1L UV detector, autosampler, column thermostat and software
A460012	Binary UHPLC system with DAD 6.1L UV/VIS detector, autosampler cool/heat, column thermostat and OpenLAB® software
A460013	Quaternary UHPLC system with DAD 6.1L UV/VIS detector, autosampler cool/heat, column thermostat and OpenLAB® software

AZURA® Bio SEC 10

System for easy size exclusion chromatography

The AZURA® Bio SEC 10 was designed for easy and isocratic FPLC applications like size exclusion chromatography. Thanks to its compact design and user friendly FPLC software PurityChrom®, the system offers outstanding performance and ease of use. Inject your sample via the injection valve and detect your substances using the the integrated UV detector. The fraction collector collects your purified fractions reliably. Pre-designed methods are included in the software and can be easily adapted by changing the column volume. We recommend preparative and semi-preparative columns. For analytical and micro-preparative scale columns please use our AZURA® Pump P6.1L (article no. APH60EB).

Key features

- Injection valve for sample injection
- Variable single wavelength UV-detector (190-500 nm)
- Flow rate: 0,001-10 ml/min; 0.2-5.0 ml/min (recommended)
- Fraction collector
- 100% compatible to all biochromatography columns
- PurityChrom® software
- Maximum operating pressure: 150 bar

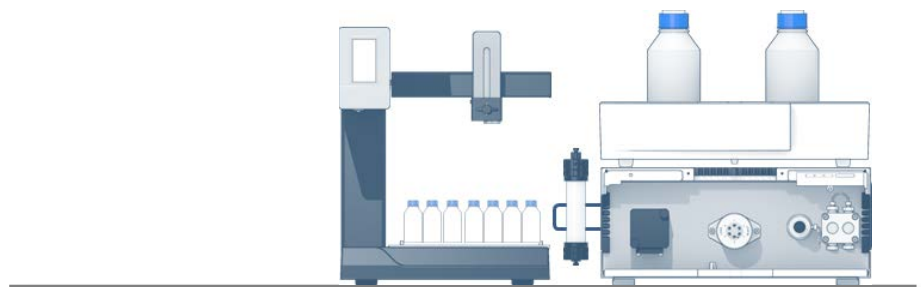

Ordering details:

A49001 Isocratic FPLC-system with UV-detector, injection valve, fraction collector and PurityChrom® software

AZURA® Bio AC

System for affinity chromatography

The AZURA® Bio AC was designed for isocratic affinity chromatography applications. The system offers outstanding performance and ease of use thanks to its compact design and user friendly FPLC software PurityChrom®. Select your sample, your washing and elution buffer using the selection valve. Your proteins of interest are detected by UV and automatically collected via the fractionation valve. Pre-designed methods and cleaning steps are included in the software and can be easily adapted by changing the column volume.

Key features

- Automatic sample/ buffer selection valve for up to 6 buffers or samples (e.g. 1. washing buffer, 2. elution buffer and 4 samples or alternatively 1. washing buffer, 2. elution buffer, 3. sample, 4. CIP solution, 5. storage solution, 6. water)
- Fraction valve (6 ports) for fractionation
- Flow rate: 0.01-50 ml/min; 0.5-40 ml/min (recommended)
- Variable single wavelength UV-detector (190-500 nm)
- 100% compatible to all biochromatography columns
- PurityChrom® software
- Maximum operating pressure: 150 bar

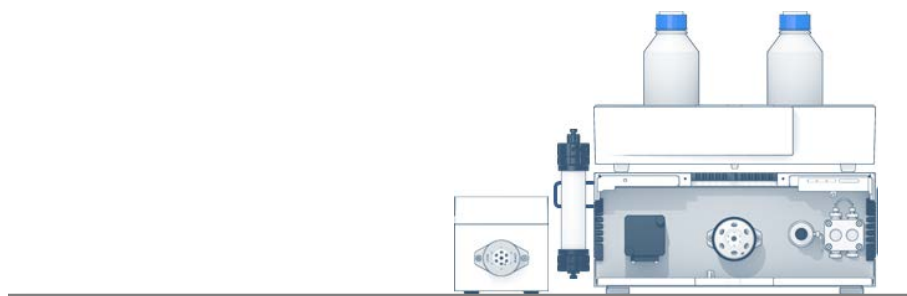

Ordering details:

A49002 Isocratic FPLC-system with UV-detector, injection valve, fraction collector valve and PurityChrom® software

AZURA® Bio Lab 10 LPG

System for more complex FPLC applications

AZURA® Bio Lab 10 LPG is a gradient system for more complex purification of biomolecules on a laboratory scale. It is designed and optimized for all FPLC applications like size exclusion, ion exchange and affinity chromatography.

All system modules can be freely exchanged and further ones can be added optionally, to find the best configuration for each purification task.

The system proposal consists of a biocompatible buffer pump equipped with the possibility to perform a gradient between four buffers. Monitor your gradient over the whole run using the conductivity monitor. Inject your sample via the injection valve and detect your substances using the integrated single wavelength UV detector. The fraction collector collects your purified fractions reliably. The system is controlled via user friendly FPLC software PurityChrom®. This software offers a high flexibility in method development and provides you with complete control over your run. Pre-designed methods are included in the software and can be easily adapted by changing the column volume.

Key features

- Complete gradient system for all FPLC applications
- Variable single wavelength UV detector
- Conductivity monitoring
- Gradient out of 4 buffers
- Flow rate up to 10 ml/min
- Fraction collector
- 100% compatible to all biochromatography columns
- PurityChrom® software
- Maximum operating pressure: 150 bar

Optional features

- Multiple buffer & sample selection
- Sample pump
- pH measurement
- Column selection
- Airsensor
- Delta pressure measurement
- Autosampler

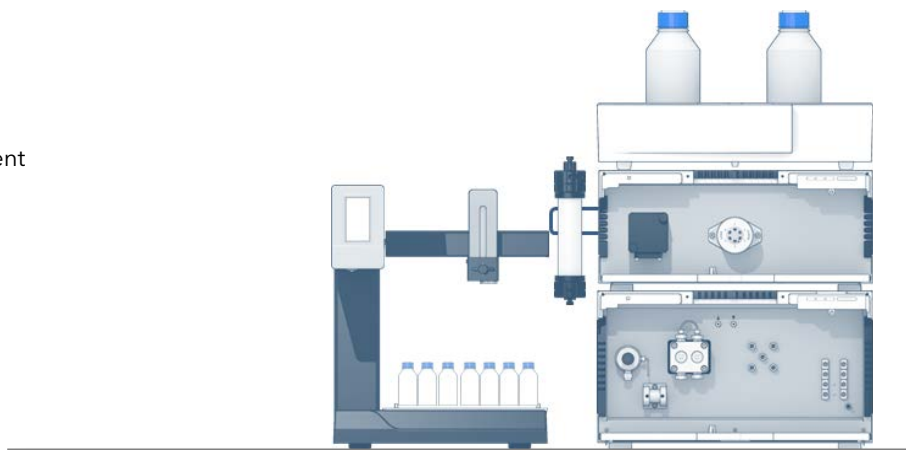

Ordering details:

A49003	AZURA® Bio Lab 10 LPG
A49004	AZURA® Bio Lab 10 LPG with conductivity monitor
A49005	AZURA® Bio Lab 10 LPG with conductivity and ph monitor

AZURA® Bio Lab 10/50 HPG

System for more complex FPLC applications

AZURA® Bio Lab 10/50 HPG is a gradient system for more complex purification of biomolecules on a laboratory scale. It is designed and optimized for all FPLC applications like size exclusion, ion exchange and affinity chromatography.

All system modules can be freely exchanged and further ones can be added optionally, to find the best configuration for each purification task.

The system proposal consists of a biocompatible buffer pump equipped with two pump heads to perform a gradient between two buffers. Monitor your gradient over the whole run using the conductivity monitor. Inject your sample via the injection valve and detect your substances using the integrated single wavelength UV detector. The fraction collector collects your purified fractions reliably. The system is controlled via user friendly FPLC software PurityChrom®. This software offers a high flexibility in method development and provides you with complete control over your run. Pre-designed methods are included in the software and can be easily adapted by changing the column volume.

Key features

- Complete gradient system for all FPLC applications
- Variable single wavelength UV-detector
- Conductivity monitoring
- Gradient out of 2 buffers, 4 buffer inlets
- Flow rate up to 50 ml/min
- Fraction collector for fractionation
- 100% compatible to all biochromatography columns
- PurityChrom® software
- Maximum operating pressure: 150 bar

Optional features

- Multiple buffer & sample selection

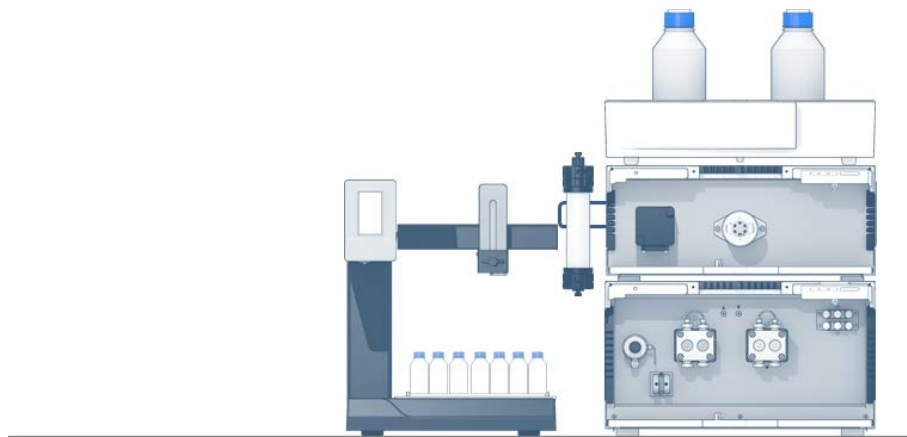

Ordering details:

A49006	AZURA® Bio Lab 10 HPG with conductivity monitor
A49007	AZURA® Bio Lab 50 HPG with conductivity monitor
A49008	AZURA® Bio Lab 10 HPG with conductivity and ph monitor
A49009	AZURA® Bio Lab 50 HPG with conductivity and ph monitor

AZURA® Bio Lab Plus

System for more complex FPLC applications

AZURA® Bio Lab Plus is a gradient system for more complex purification of biomolecules on a laboratory scale. It is designed and optimized for all FPLC applications like size exclusion, ion exchange and affinity chromatography.

All system modules can be freely exchanged and further ones can be added optionally, to find the best configuration for each purification task.

The system proposal consists of a biocompatible buffer pump equipped with two pump heads to perform a gradient between two buffers. Select between 12 buffers and 6 samples. Monitor your gradient over the whole run using the conductivity monitor. Inject your sample via the injection valve or sample pump. Use up to 5 columns and reverse the flow using the column selection valve. Detect your substances using the integrated multi wavelength UV detector. The fraction collector collects your purified fractions reliably. The system is controlled via user friendly FPLC software PurityChrom®. This software offers a high flexibility in method development and provides you with complete control over your run. Pre-designed methods are included in the software and can be easily adapted by changing the column volume.

Key features

- Complete gradient system for all FPLC applications
- Multi wavelength UV-detector
- Conductivity monitoring
- Gradient out of 2 buffers, 12 buffer inlets and 6 sample inlets
- Flow rate up to 50 ml/min
- Sample injection via injection valve or sample pump
- Column selection for 5 columns & reverse flow option
- Fraction collector for fractionation
- 100% compatible to all biochromatography columns
- PurityChrom® software
- Maximum operating pressure: 150 bar

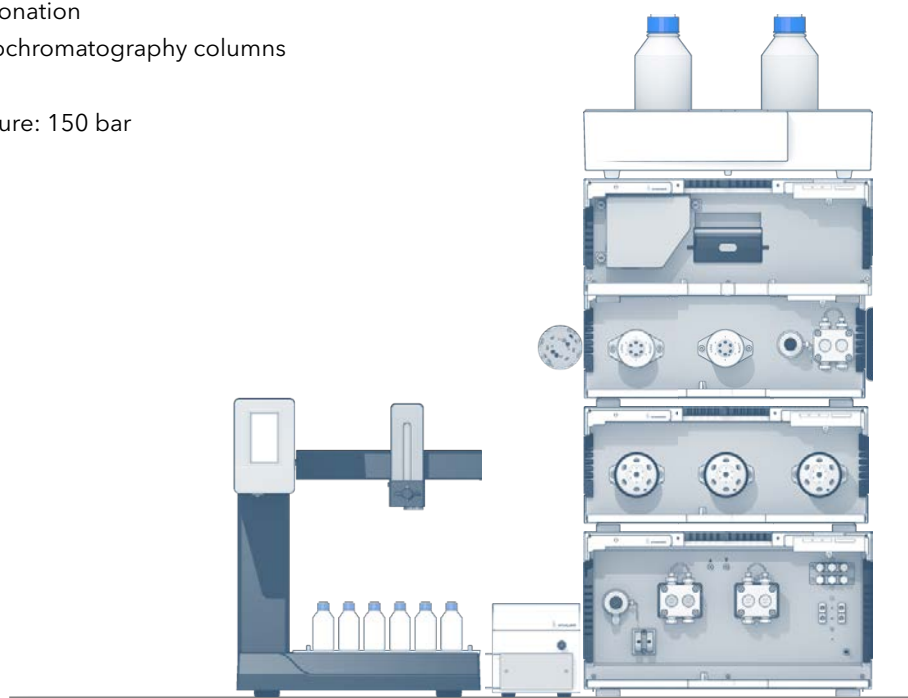

Ordering details:

A49010 AZURA® Bio Lab Plus with conductivity monitor

AZURA® Bio Pilot 100/250/500 LPG

System for scale-up and process applications

AZURA® Bio Pilot 100/250/500 LPG was designed for scale-up and process applications in laboratory scale. The AZURA® Pilot FPLC system is optimized for the purification of milligram to gram samples.

All system modules can be freely exchanged and further ones can be added optionally, to find the best configuration for each purification task.

The system proposal consists of a biocompatible buffer pump equipped with the possibility to perform an accurate binary or ternary gradient using the attached LPG valve block. Monitor your gradient over the whole run using the conductivity monitor. Inject your sample via the buffer pump and the integrated injection valve. The wavelength to detect your sample is freely selectable. The fraction collector collects your purified fractions reliably. The system is controlled via user friendly FPLC software PurityChrom®. This software offers a high flexibility in method development and provides you with complete control over your run. Pre-designed methods are included in the software and can be easily adapted and upscaled by changing the column volume.

The system is designed in different tubing diameter.

Key features

- Complete low pressure gradient FPLC system for purification of mg and gram samples
- Variable single wavelength UV-detector (190-500 nm)
- Optional conductivity monitoring with optional pH measurement
- Flow rate: 0.1-100 ml/min; 0.2-80 ml/min (recommended)
- Sample injection via sample pump up to 50 ml/min and loop
- Fraction collector for fractionation
- 100% compatible to all biochromatography FPLC columns
- PurityChrom® software

Optional features

- Multiple buffer & sample selection
- Sample pump
- PH measurement
- Column Selection
- Airsensor
- Delta pressure measurement
- Autosampler

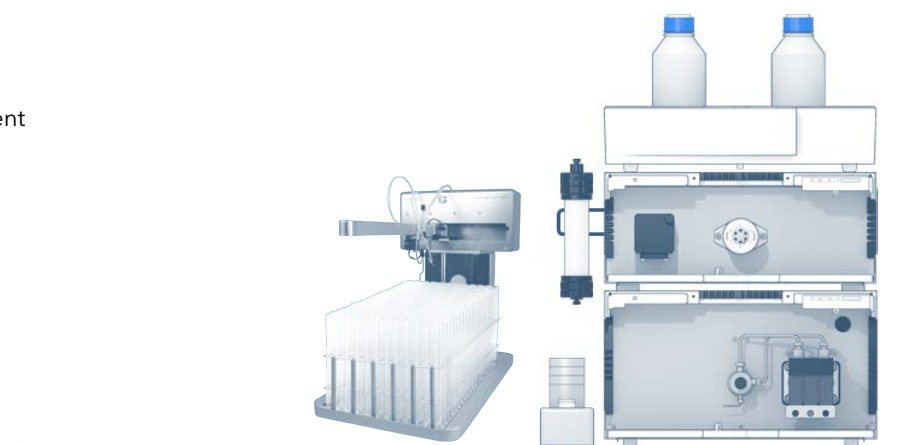

Ordering details:

A49011	AZURA® Bio Pilot 100 LPG with 1/16" tubing
A49012	AZURA® Bio Pilot 250 LPG with 1/8" tubing
A49013	AZURA® Bio Pilot 500 LPG with 1/4" tubing
A49014	AZURA® Bio Pilot 100 LPG with 1/16" tubing with conductivity monitor
A49015	AZURA® Bio Pilot 250 LPG with 1/8" tubing with conductivity monitor
A49016	AZURA® Bio Pilot 500 LPG with 1/4" tubing with conductivity monitor

AZURA® Bio Pilot 100/250/1000 HPG

System for scale-up and process applications

AZURA® Bio Pilot 100/250/1000 HPG was designed for scale-up and process applications in laboratory scale. The system is optimized for the purification of milligram to gram samples.

All system modules can be freely exchanged and further ones can be added optionally, to find the best configuration for each purification task.

The system proposal consists of two biocompatible buffer pumps to perform gradient between two buffers. Monitor your gradient over the whole run using the conductivity monitor. Inject your sample via the sample pump and the integrated injection valve. The wavelength to detect your sample is freely selectable. The fraction collector collects your purified fractions reliably. The system is controlled via user friendly FPLC software PurityChrom®. This software offers a high flexibility in method development and provides you with complete control over your run. Pre-designed methods are included in the software and can be easily adapted

The system is designed in different tubing diameter.

Key features

- Complete high pressure gradient FPLC system for purification of mg and gram samples
- Variable single wavelength UV-detector (190-500 nm)
- Optional conductivity monitoring with optional pH measurement
- Flow rate: 0.1-100 ml/min; 0.2-80 ml/min (recommended)
- Sample injection via sample pump up to 50 ml/min and injection valve
- Fraction collector for fractionation
- 100% compatible to all biochromatography columns
- PurityChrom® software

Optional features

- Multiple buffer & sample selection
- Sample pump
- PH measurement
- Column Selection
- Airsensor
- Delta pressure measurement
- Autosampler

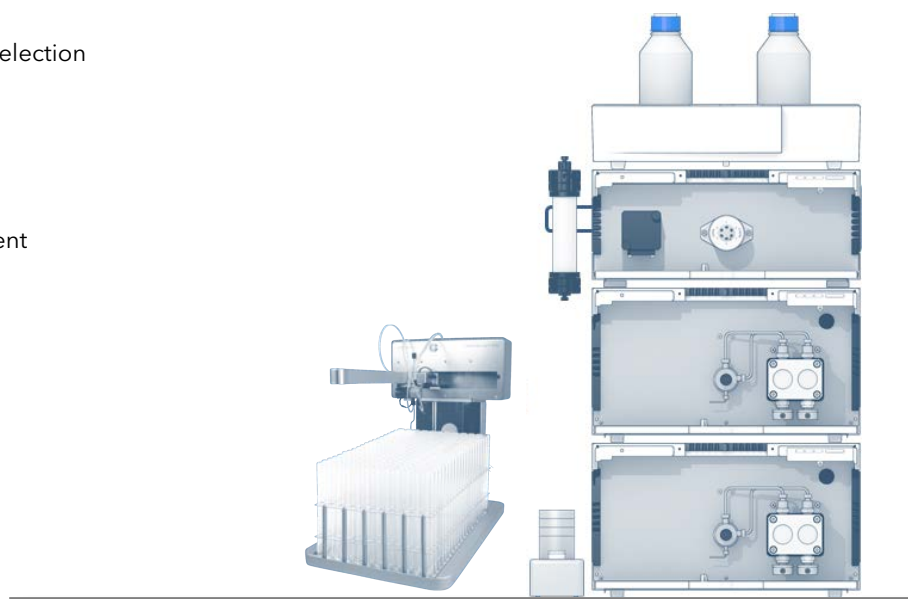

Ordering details:

A49017	AZURA® Bio Pilot 100 HPG with 1/16" tubing
A49018	AZURA® Bio Pilot 250 HPG with 1/8" tubing
A49019	AZURA® Bio Pilot 1000 HPG with 1/4" tubing
A49020	AZURA® Bio Pilot 100 HPG with 1/16" tubing with conductivity monitor
A49021	AZURA® Bio Pilot 250 HPG with 1/8" tubing with conductivity monitor
A49022	AZURA® Bio Pilot 1000 HPG with 1/4" tubing with conductivity monitor

AZURA® Prep Compact 50 iso

System for process applications

The AZURA® Prep Compact 50 iso with 50 ml pump head is a complete semi-preparative high pressure HPLC system. Due to its extremely compact dimensions, the system fits even onto the smallest laboratory bench.

The system consists of an AZURA® Assistant ASM 2.1L with integrated pump, detector and fraction collector valve and comes with an eluent tray for safe storage of up to six bottles.

Injection is performed via a manual injection valve. The column can be attached anywhere to the system via magnetic clip. Larger columns can be placed very easy on the KNAUER prism next to the system. Solvent bottles can be stored in an eluent tray on top of the system. A leak sensor and the capillary guidance is provided as well as a tablet with Mobile Control Chrom. Modern design with completely demountable fronts turn the system into a visual highlight.

Key features

- Complete semi-preparative isocratic HPLC system that needs very little bench space
- UV detector with one variable wavelength
- Purification of several hundred mg
- Mobile Control for maintenance
- Leakage protection
- Compact and expandable
- Alternative PurityChrom® enhanced fraction control



Ordering details:

A48006	AZURA® Prep Compact 50 iso with 1/16" tubing, max. 150 bar, fractionation with 16P valve and Mobile Control
A48007	AZURA® Prep Compact 50 iso with 1/16" tubing, max. 150 bar, fractionation with 16P valve and PurityChrom®

AZURA® Prep Lab 50 HPG

System for process applications

The AZURA® Prep Lab 50 HPG with 50 ml pump head is a completely automated semi-preparative high pressure gradient HPLC system.

The system consists of an AZURA® Pump P 6.1L, an AZURA® Detector UVD 2.1S, an electric injection valve, a fraction collector LABOCOL Vario-4000 and comes with an eluent tray for safe storage of up to six bottles. The pump can deliver flow in the range of 0.01 - 50 mL/min at pressures up to 300 bar. The binary pump contains two identical high pressure pumps (300 bar up to 10 ml/min, 200 bar up to 50 ml/min), 2×2-channel inlet solvent selection valve and the new developed AZURA® Mixer, a low-volume mixing device.

The fraction collector LABOCOL Vario-4000 is ideal for applications including prep HPLC, protein, and peptide purifications. The column can be attached anywhere to the system via magnetic clip. Larger columns can be placed very easy on the KNAUER prism next to the system. Solvent bottles can be stored in an eluent tray on top of the system. Additional features like the leak sensor, the capillary guidance and a tablet with Mobile Control are increasing the security as well as the handling of the systems. Modern design with completely demountable fronts turn the system into a visual highlight.

The stackable elements of AZURA® allow to create complex system solutions requiring only a minimum of space.

Key features

- Complete high pressure gradient HPLC system that needs very little bench space
- 2×2-channel inlet solvent selection valve
- Constant pressure operation mode
- UV detector with one variable wavelength
- Leakage protection
- PurityChrom® software
- Mobile Control for maintenance
- Fraction collector

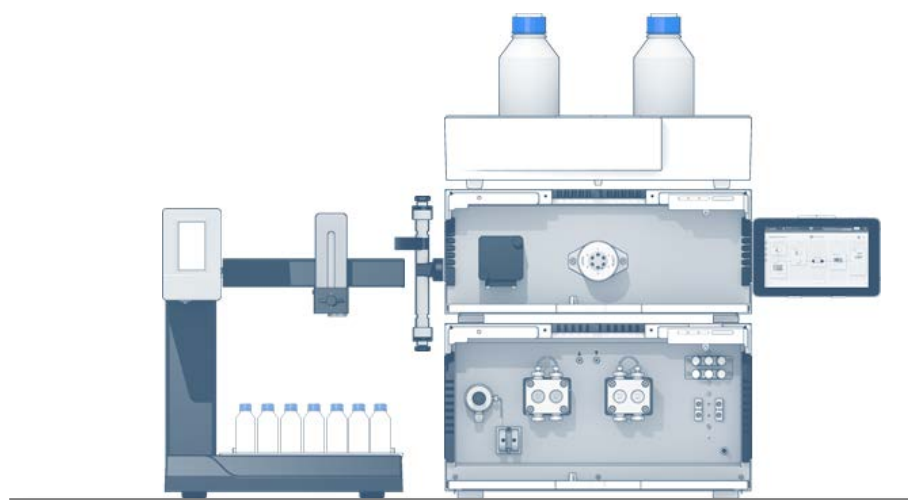

Ordering details:

A48008	AZURA® Prep Lab 50 HPG with 1/16" tubing, max. 300 bar, fractionation with 16P valve
A48009	AZURA® Prep Lab 50 HPG with 1/16" tubing, max. 300 bar, fraction collector

AZURA® Prep Pilot 100/250/500 LPG

System for process applications

The AZURA® Prep Pilot 100/250/500 LPG is a low pressure gradient (LPG) HPLC system for the purification of samples in the laboratory scale. The AZURA® Preparative HPLC system is designed and optimized for the purification of milligram to gram samples. The system proposal consists of a preparative HPLC pump with ternary or binary LPG valve block and an AZURA® Assistant ASM 2.1 L with an AZURA® Detector UVD 2.1S and an electric injection valve for injection of small sample volumes.

The AZURA® Pump P 2.1L covers a wide flow rate range and pressure capabilities. In the current setup, it supports max. pressures up to 400 bar at flow rates up to 100 ml/min. The integrated automatic recognition of the pump head with RFID technology allows fast adaptations of the pump for various applications. The LPG valve block enables the accurate formation of binary or ternary gradients.

The AZURA® Preparative HPLC System comes with an eluent tray for safe storage of eluent bottles and an integrated leak management system with sensors.

VertexPlus AX columns (20 mm and 30 mm ID) can be attached with an optional AZURA® mounting bracket at both sides of each AZURA® element. A leak sensor and the capillary guidance as well as the optional control unit with touch screen facilitate the safe and user friendly operation. Modern design with completely demountable fronts and exchangeable colored side panels turn the system into a visual highlight.

Key features

- Complete low pressure gradient FPLC system for purification of mg and gram samples
- Variable single wavelength UV detector (190-500 nm)
- Optional conductivity monitoring with optional pH measurement
- Flow rate: 0.1-500 ml/min
- Fraction collector for fractionation
- PurityChrom® software
- Mobile Control for maintenance

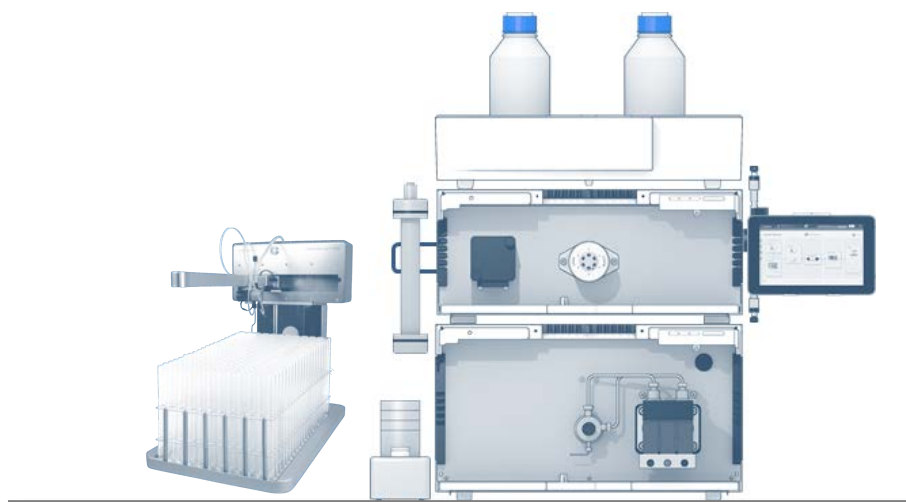

Ordering details:

A48010	AZURA® Prep Pilot 100 LPG with 1/16" tubing, max 400 bar, with LABOCOL Vario-4000
A48011	AZURA® Prep Pilot 250 LPG with 1/8" tubing, max 200 bar, with LABOCOL Vario-4000
A48012	AZURA® Prep Pilot 500 LPG with 1/8" tubing, max 100 bar, with LABOCOL Vario-4000

AZURA® Prep Pilot 100/250/500/1000 HPG

System for process applications

The AZURA® Prep Pilot 100/250/500/1000 HPG is a complete binary high pressure gradient (HPG) HPLC system for the purification of samples in the laboratory scale. It is designed and optimized for the purification of milligram to few gram samples. This system proposal consists of two preparative HPLC pumps, an UV/VIS detector and a freely customizable combination module.

The AZURA® Pump P 2.1L covers a wide flow rate range and pressure capabilities. In the current setup, it supports max. pressures up to 400 bar at flow rates up to 100 ml/min. The integrated automatic recognition of the pump head with RFID technology allows fast adaptations of the pump for various applications. The HPG setup enables the precise formation of binary gradients. Besides, ternary and quaternary gradients are accessible by integration of additional preparative pumps.

The AZURA® Detector UVD 2.1S represents a UV/VIS detector with a variable single wavelength for the detection of fast eluting peaks.

The system can easily expand by an AZURA® Assistant ASM 2.1L for preparative HPLC. The assistant module can be customized to individual requirements. For example, to enable automatic injection and fraction collection, the assistant module contains three integrated modules:

- Large sample volumes can be applied automatically via the integrated injection valve and feed pump.
- The integrated fractionation valve enables sample fractionation without an additional fraction collector.
- Under isocratic conditions, the consumption of solvent can be reduced by the use of solvent recycling at high flow rates. Peak recycling allows improving the resolution of a pair of closely eluting solutes (e.g., a pair of enantiomers) by automated repeated processing of the peaks.

The system comes with an eluent tray for safe storage of eluent bottles and an integrated leak management system with sensors.

Key features

- Complete high pressure gradient preparative HPLC system for purification of mg and gram samples
- Injection valve and feed pump for automated injection of large sample volumes
- Pump offers a wide range of flow rates (0.1-1000 ml/min)
- Automatic recognition of the pump head with RFID technology
- UV/VIS detector with a variable single wavelength
- Fractionation valve for fraction collection, solvent and peak recycling
- Leakage protection
- Customizable
- Mobile Control for maintenance

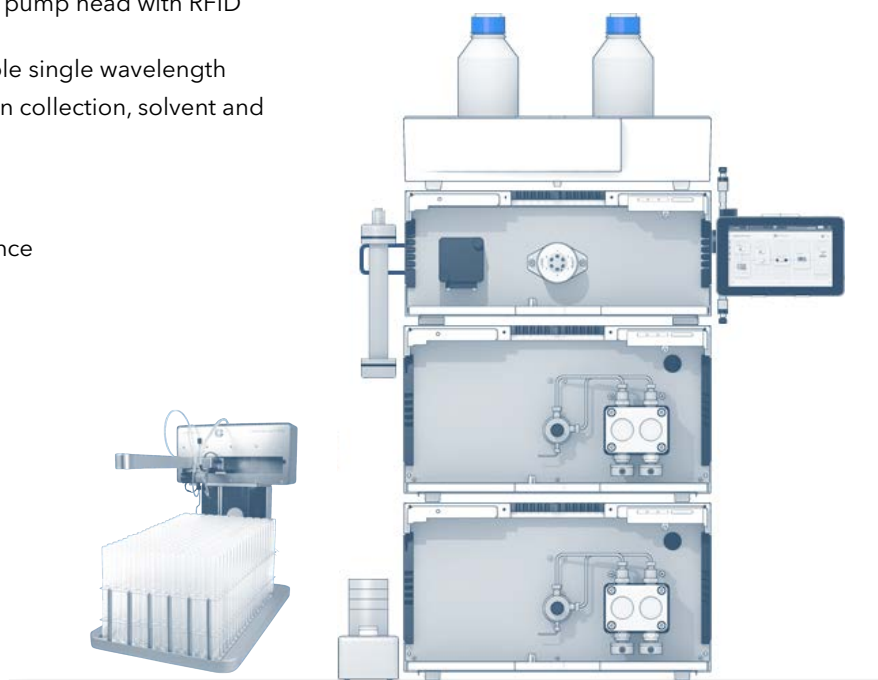

Ordering details:

A48013	AZURA® Prep Pilot 100 HPG with 1/16" tubing, with fraction collector
A48014	AZURA® Prep Pilot 250 HPG with 1/8" tubing, max 200 bar, with LABOCOL Vario-4000
A48015	AZURA® Prep Pilot 500 HPG with 1/8" tubing, max 100 bar, with LABOCOL Vario-4000
A48016	AZURA® Prep Pilot 1000 HPG with 1/4" tubing, max 50 bar, with LABOCOL Vario-4000

AZURA® Prep Pilot 100/250 HPG (with multicolumn auto-inject)

System for scale-up and process applications

The AZURA® Prep Pilot 100/250 HPF with multicolumn auto-inject is designed for scale-up and process applications in laboratory scale. The system is optimized for the purification of milligram to gram samples.

All system modules can be freely exchanged and further ones can be added optionally, to find the best configuration for each purification task.

The system proposal consists of two eluent pumps to perform gradient between two eluents. Inject your sample via the AZURA® Autosampler AS 6.1L with prep configuration or the KNAUER VariLoop. The wavelength to detect your sample is freely selectable. The fraction collector collects your purified fractions reliably. The system is controlled via user friendly FPLC software PurityChrom®. This software offers a high flexibility in method development and provides you with complete control over your run. Pre-designed methods are included in the software and can be easily adapted and upscaled by changing the column volume.

The system is designed for 1/8" capillaries and on request in 1/16".

Key features

- Complete high pressure gradient prep LC system for purification of mg and gram samples
- AZURA® Autosampler AS6.1L with prep configuration and KNAUER VariLoop 40 ml
- Variable single wavelength UV detector (190-500 nm)
- Optional multichannel wavelength detector
- Column selection valve for up to 6 columns
- Flow rate: 0.1-250 ml/min
- Fraction collector LABOCOL Vario-4000 for fractionation
- PurityChrom® software
- Mobile Control for maintenance

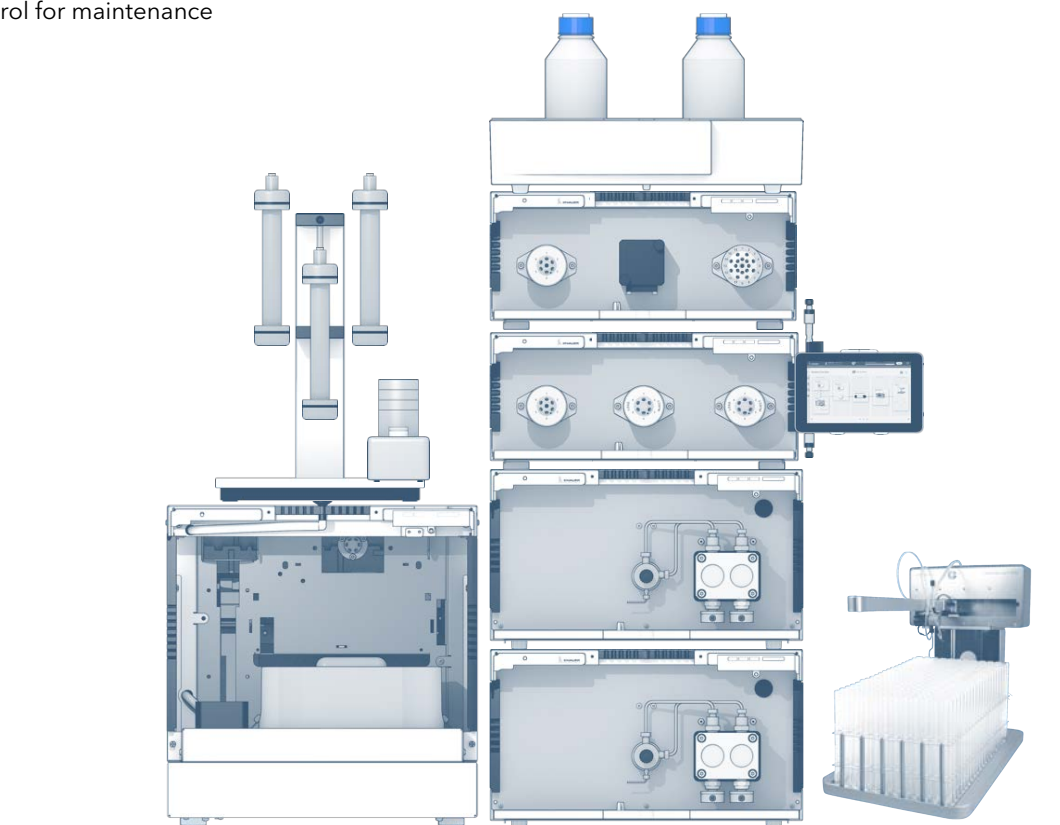

Ordering details:

A48017	AZURA® Prep Pilot 100 HPG, multicolumn auto-inject with 1/16" tubing, with fraction collector
A48018	AZURA® Prep Pilot 250 HPG, multicolumn auto-inject with 1/8" tubing, with LABOCOL Vario-4000

AZURA® GPC Cleanup

Preparative system for general cleanup tasks relying on gel permeation

Prior to many analysis procedures interfering components in samples must be removed. Sample preparation based on Gel Permeation Chromatography (GPC) separates molecules according to their size and shape. High-molecular weight substances are removed and small target molecules are collected for analysis.

Manual sample preparation based on GPC is work-intensive and time consuming. Human resources and time are saved by automation of the cleanup task. After sample loading, the AZURA GPC cleanup system fully automatically processes up to 15 samples without manual intervention. Further, reproducibility and quality of the cleanup are improved and kept at a constant level. The general cleaning approach is employed on a wide range of sample matrices such as foodstuffs, tissues, plants and environmental samples.

The system features 15 sample loops controlled by two selection valves. Stored in a tray with drainage system the wound-up sample loops are easily accessible for inspection and replacement. The GPC tubing guide sorts outlet tubings coming from the fraction collection valve. Besides the waste, 15 fractions can be collected. The elution of separated reference standard components is monitored by a variable single wavelength UV detector. A compact pump based on dual-piston technology ensures constant flow rates, crucial for high-resolution GPC. A pressure sensor at the pump control monitors the system pressure during the runs. In addition to the injection valve, a second valve is included to bypass the GPC column or select between two columns.

Mobile Control is a specially designed control software with touch-optimized user interface and clearly structured menus guaranteeing intuitive handling of the AZURA GPC cleanup system.

GPC Cleanup is an established method according to several guidelines:

- Method 984.21 - AOAC international
- SW-846 Method 3640A - US Environmental Protection Agency
- AEN 12393 and EN 1528 - European Standard
- L 00.00-34 Method in accordance with §64 LFGB (formerly § 35 LMBG)

Key features

- Complete sample preparation system for general cleanup tasks relying on gel permeation
- 15 sample loops (each 1 ml or 5 ml) controlled by two selection valves
- GPC tubing guide sorts outlet tubings coming from the fraction collection valve
- Variable single wavelength UV-detector (190 - 500 nm)
- Pump with pressure sensor based on dual-piston technology for a low pulsation
- Valve to bypass the GPC column or select between two columns
- Mobile Control Chrom for system control
- 10" tablet with Windows 10
- Leakage protection
- Installation guide with capillary scheme
- Application note

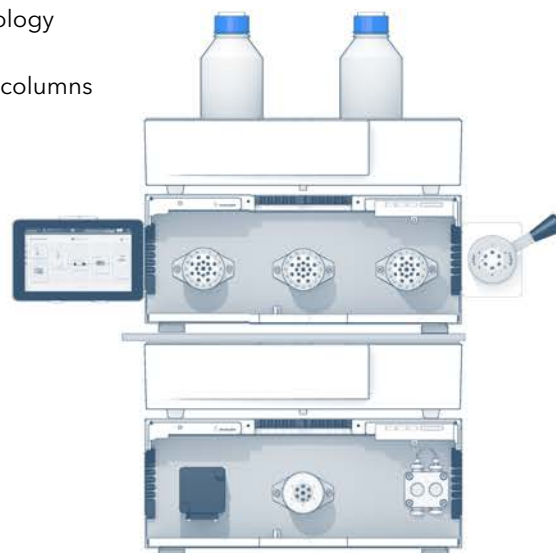

Ordering details:

A48003 AZURA® GPC Cleanup

AZURA® Online SPE

Dedicated system

Beforehand of sensitive analyses, e.g. the detection of contaminants in drinking water, often an analyte concentration is required. For these tasks we specifically designed a system for automated solid phase extraction (SPE) and subsequent analyte detection.

Our versatile AZURA® Assistant ASM 2.1L with two switching valves AZURA® V 2.1S and an AZURA® Pump P 4.1S enables an efficient online SPE to concentrate analytes prior to HPLC analysis. This significantly reduces analysis time as time consuming steps of sample preparation are automated. In addition the analyte yield is increased and sample contamination is reduced.

Afterward, separation and analysis can be achieved with a classical KNAUER AZURA analytical system equipped with AZURA® Pump P 6.1L LPG, a column thermostat AZURA® CT 2.1 and an AZURA® Detector MWD 2.1L to detect up to eight different wavelengths simultaneously.

Key features

- Automated sample preparation
- Variable multichannel UV/VIS detector
- Pump unit with pressure sensor for a low pulsation eluent supply (max. 700 bar)
- Mobile control for maintenance
- Introduction to operation of software and hardware via short movies
- Complete software package ClarityChrom®
- Leakage protection
- PC with Monitor
- Tubing scheme
- Application note

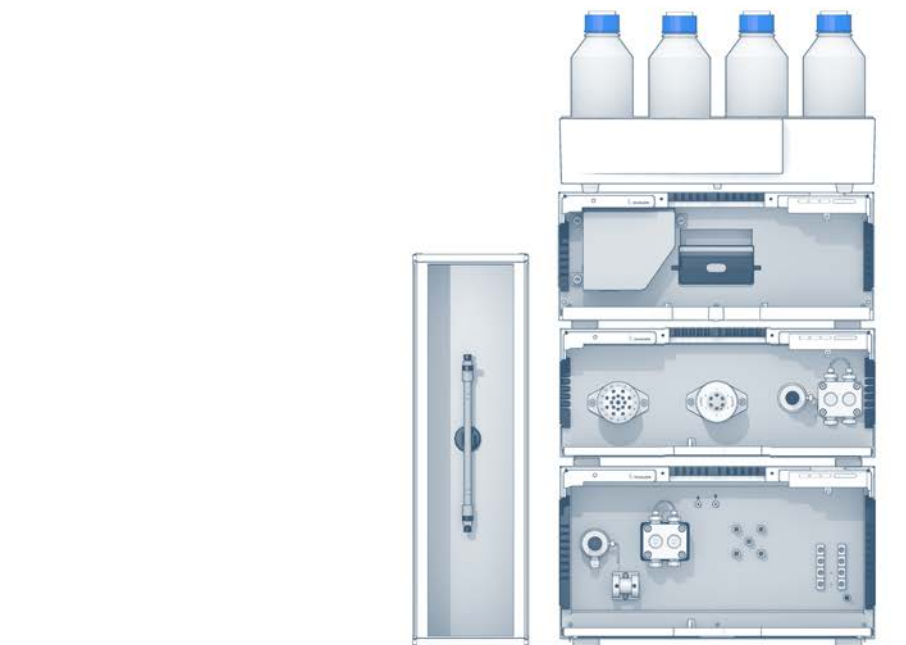

Ordering details:

A46016 AZURA® Online SPE system with SPE assistant, quaternary pump, multi-wavelength detector, column thermostat and software

System configurator

HPLC/UHPLC by KNAUER

MAKE YOUR PRESELECTION

- UHPLC**
 (SST, max. 1000 bar)
- HPLC**
 (SST, max. 700 bar)
- Bio-Inert**
 (metal-free, max. 400 bar)

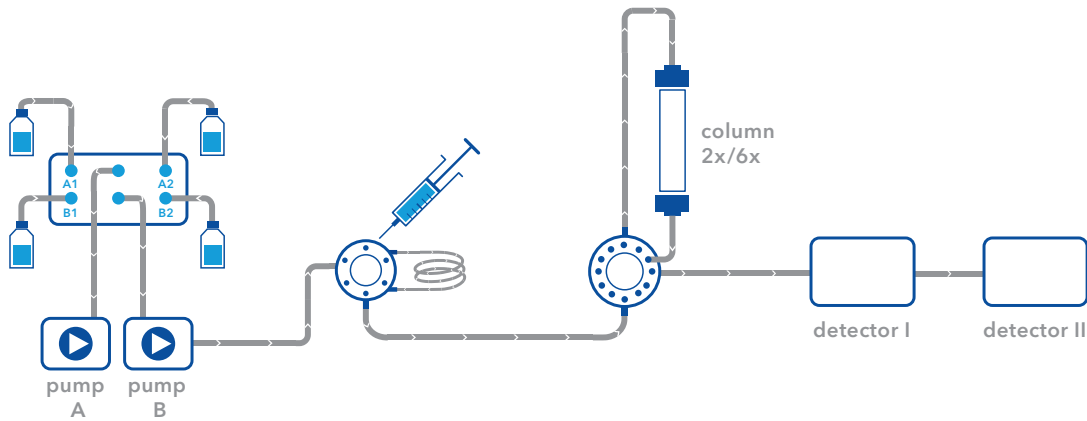

BUFFER SELECTION & DELIVERY

- 5 ml/min binary gradient pump P 6.1L (UHPLC)
- 5 ml/min quaternary gradient pump P 6.1L (UHPLC)
- 10 ml/min binary gradient pump P 6.1L
- 10 ml/min quaternary pump P 6.1L
- x solvent selection valve (6 further inlets)

SAMPLE INJECTION

- Manual injection valve
- Autosampler AS 6.1L
- Autosampler AS 6.1L cool/heat

COLUMN SELECTION & THERMOSTAT

- 2 columns
- 6 columns
- Column thermostat
- Column kit HPLC
- Column kit UHPLC
- Precolumn heater 0.1mm ID UHPLC
- Precolumn heater 0.18mm ID HPLC

DETECTION

- UV/VIS single wavelength
- UV/VIS multiple wavelength
- Conductivity
- pH
- Refractive index
- Light Scattering
- A/D-converter (integration of further detectors)
- DAD 2.1L
- DAD 6.1L
- MSQ Microsaic
- Fluorescence Detector RF-20 A
- Fluorescence Detector RF-20 Axs

ACCESSORIES

- 0.1 m tubing
- 0.18 m tubing
- PEEK tubing
- x Back pressure regulator
- Workstation (Windows)

FLOW CELLS FOR UV-DETECTOR

- 10 mm/10 µl Pressure proof
- 10 mm/2 µl LightGuide®
- 50 mm/6 µl LightGuide®
- 3 mm/2 µl (up to 100 ml/min) Pressure proof

SOFTWARE

- ClarityChrom®
- OpenLAB®
- Chromeleon™
- Mobile Control

COMMON APPLICATIONS

- Reversed phase
- Normal phase
- other...
- System Qualification

System configurator

Bio purification by KNAUER

METHOD

- SEC**
Size Exclusion Chromatography
- AC**
Affinity Chromatography
- IEX**
Ion-Exchange Chromatography
- HIC**
Hydrophobic Interaction Chromatography

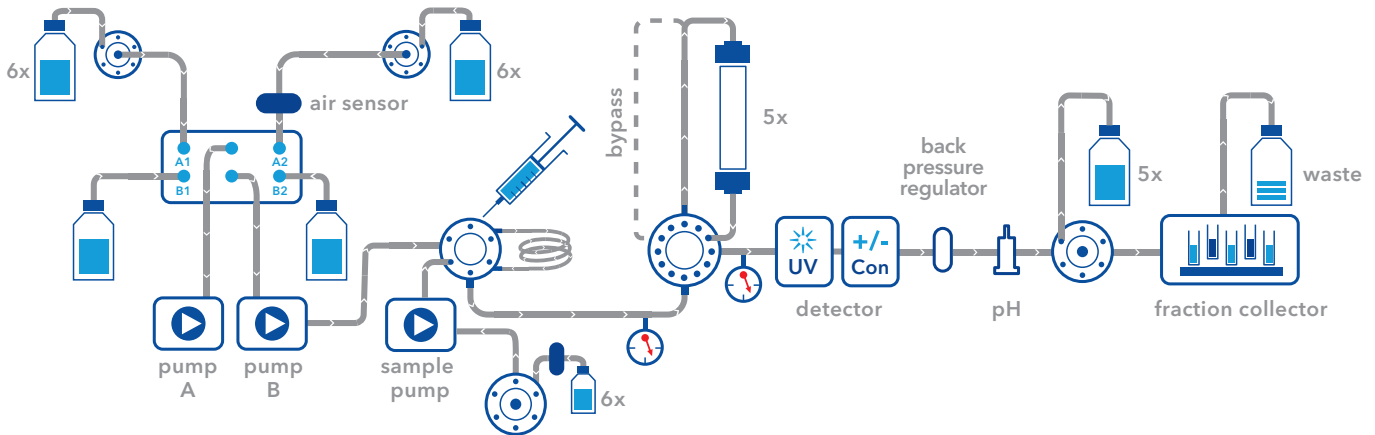

BUFFER SELECTION & DELIVERY

- 10 ml/min binary gradient pump P 6.1L
- 10 ml/min quaternary pump P 6.1L
- 50 ml/min binary gradient pump P 6.1L
- x 100 ml/min pump P 2.1L
- x 250 ml/min pump P 2.1L
- x 500 ml/min pump P 2.1L
- x 1000 ml/min pump P 2.1L
- Ternary gradient module for pump P 2.1L
- Binary gradient module for pump P 2.1L
- x Buffer selection valve (6 further inlets)

SAMPLE INJECTION

- x Injection valve
- Sample pump module
- Sample selection valve: x inlets
- Biocompatible Autosampler AS 6.1L

COLUMN SELECTION & THERMOSTAT

- Column selection valve up to 50 ml/min (5 columns, one bypass, reverse flow)
- Column selection (two columns or one bypass)
- Column selection high flow (5 columns, one bypass)
- Column selection high flow (5 columns, one bypass, reverse flow)

DETECTION

- UV/VIS single wavelength
- UV/VIS multiwavelength
- Conductivity
- pH
- Fluorescence
- Refractive index
- Light Scattering
- Analog integration of further detectors

FRACTION COLLECTION

- Fractionation valve
- Foxy fraction collector with fixed rack types
- Labocol fraction collector with individual rack types
- Rack for fraction collector

ACCESSORIES

- x Airsensor main pump
- x Airsensor feed pump
- Pressure control (2 pressure sensors)
- x Back pressure regulator
- AZURA Organizer
- x Tubing 1/16"
- x Tubing 1/8"
- x Tubing 1/4"
- Workstation Windows)

System configurator

Preparative HPLC by KNAUER

MAKE YOUR PRESELECTION

 SST

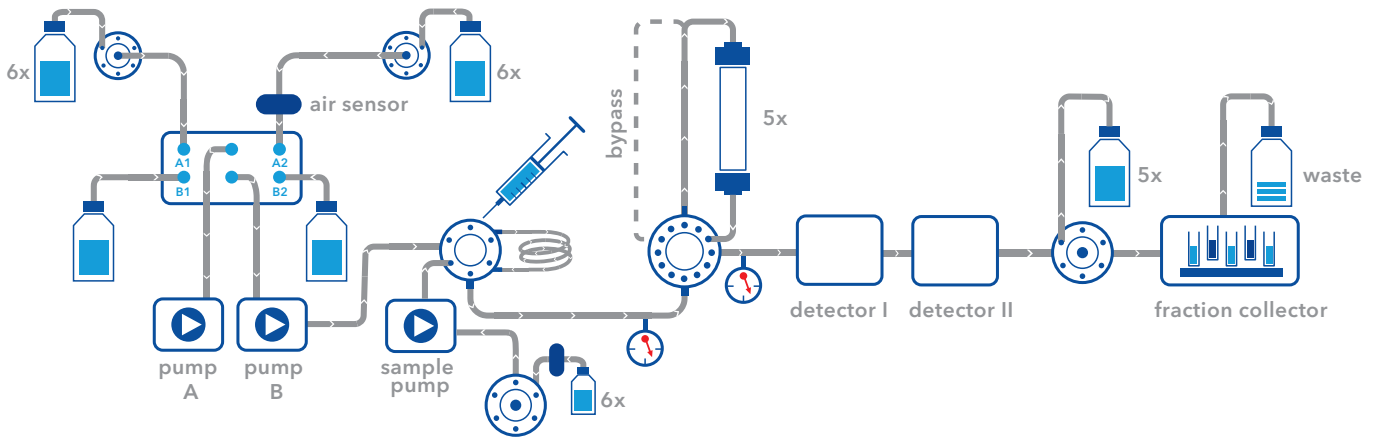
 Titanium

BUFFER SELECTION & DELIVERY

- 10 ml/min binary gradient pump P 6.1L
- 10 ml/min quaternary pump P 6.1L
- 50 ml/min binary gradient pump P 6.1L
- x 100 ml/min pump P 2.1L
- x 250 ml/min pump P 2.1L
- x 500 ml/min pump P 2.1L
- x 1000 ml/min pump P 2.1L
- Ternary gradient module for pump P 2.1L
- Binary gradient module for pump P 2.1L
- x solvent selection valve (6 further inlets)

SAMPLE INJECTION

- Injection valve
- Sample pump module
- Sample selection valve: x inlets
- Autosampler AS 6.1L

COLUMN SELECTION & THERMOSTAT

- Column selection (two columns or one bypass)
- Column selection high flow (5 columns, one bypass)

DETECTION

- UV/VIS single wavelength
- UV/VIS multiwave length
- DAD 2.1L
- Fluorescence Detector RF-20 A
- Conductivity
- pH
- Refractive index
- Light Scattering
- MSQ Microsaic
- A/D-converter (integration of further detectors)

FRACTION COLLECTION

- Fractionation valve
- Foxy fraction collector with fixed rack types
- Labocol fraction collector with individual rack types
- Rack for fraction collector
- Flow splitter

ACCESSORIES

- x Airsensor main pump
- x Airsensor feed pump
- Pressure control (2 pressure sensors)
- x Back pressure regulator
- x Tubing 1/16"
- x Tubing 1/8"
- x Tubing 1/4"
- Workstation (Windows)
- AZURA Organizer

SOFTWARE

- ClarityChrom®
- OpenLAB®
- PurityChrom®
- Chromeleon™
- Mobile Control

COMMON APPLICATIONS

- Reversed phase
- Normal phase
- other...
- System Qualification

Dimensions conversion chart

mm	inches	inches	mm
0,10	.004"	1/32"	0,8
0,12	.005"	1/16"	1,6
0,15	.006"	1/8"	3,2
0,25	.010"	1/4"	6,4
0,40	.016"	3/8"	9,5
0,50	.020"	1/2"	12,7
0,75	.030"	1"	25,4
1,00	.040"		
1,50	.060"		
2,00	.080"		
4,60	.180"		
6,00	.236"		
6,40	.253"		
7,00	.276"		
10,00	.400"		

Tubing volume/Length conversion chart

Tubing ID	µl/cm	µl/in
.004"	0,08	0,21
.005"	0.13	0.32
.010"	0.51	1.29
.015"	1.14	2.90
.020"	2.03	5.15
.025"	3.17	8.04
.030"	4.56	11.58
.040"	8.11	20.59
.060"	18.24	46.33
.070"	24.83	63.06
.085"	36.61	92.99

Pressure conversion chart

MPa	bar	psi
5	50	725
10	100	1.450
20	200	2.901
30	300	4.351
40	400	5.802
50	500	7.252
60	600	8.702
70	700	10.153
80	800	11.603
90	900	13.054
100	1.000	14.504
110	1.100	15.954
120	1.200	17.405
130	1.300	18.855
140	1.400	20.306
150	1.500	21.756
160	1.600	23.206
170	1.700	24.657
180	1.800	26.107
190	1.900	27.558
200	2.000	29.008

Temperature conversion chart

°C	°F	°C	°F	°C	°F
-40	-40	65	149	170	338
-35	-31	70	158	175	347
-30	-22	75	167	180	356
-25	-13	80	176	185	365
-20	-4	85	185	190	374
-15	5	90	194	195	383
-10	14	95	203	200	392
-5	23	100	212	205	401
0	32	105	221	210	410
5	41	110	230	215	419
10	50	115	239	220	428
15	59	120	248	225	437
20	68	125	257	230	446
25	77	130	266	235	455
30	86	135	275	240	464
35	95	140	284	245	473
40	104	145	293	250	482
45	113	150	302	255	491
50	122	155	311	260	500
55	131	160	320	265	509
60	140	165	329	270	518

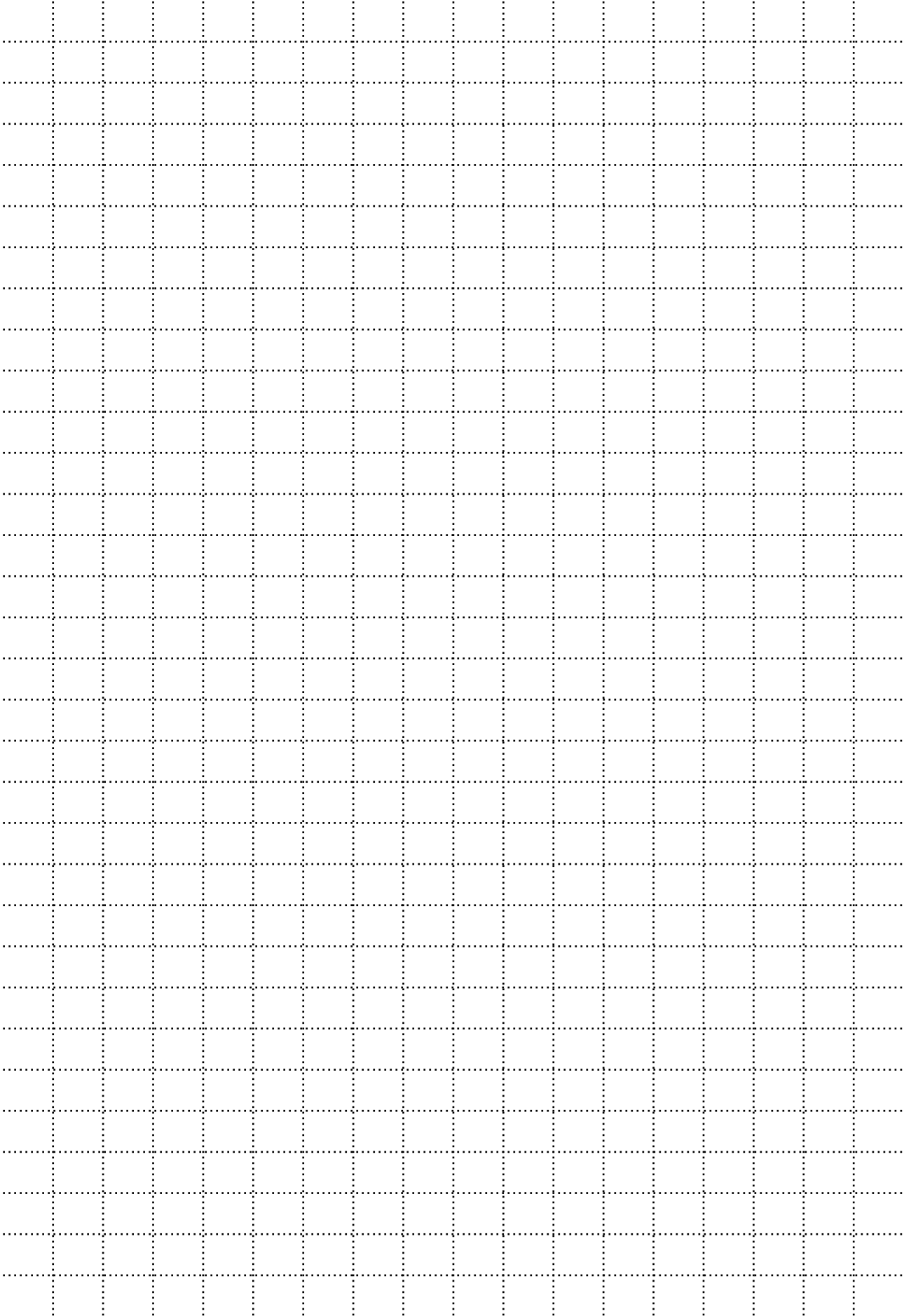

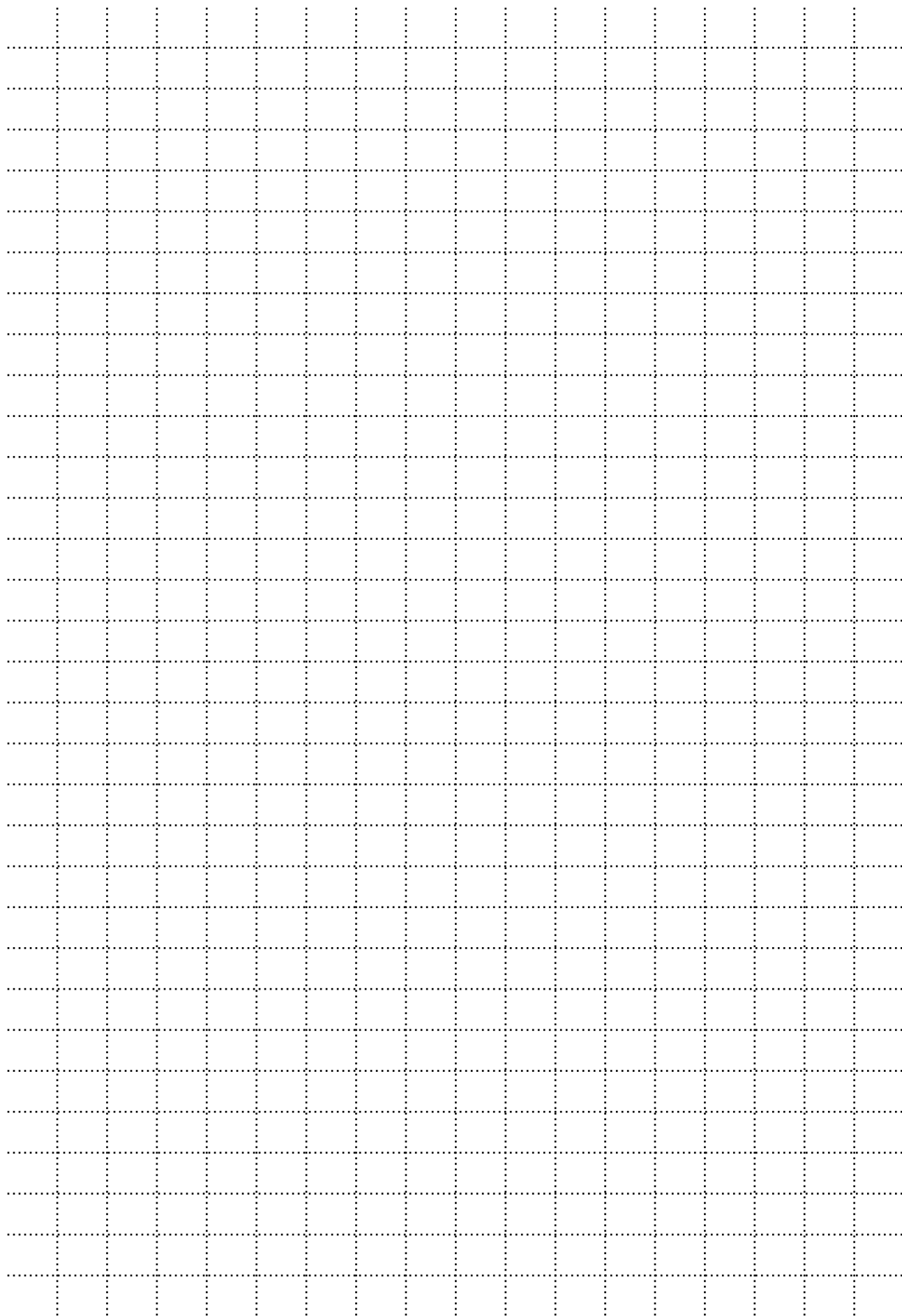

Analytical
HPLC

Multi-Column
Chromatography,
SMB

Preparative
HPLC

FPLC

Osmometry

Dosing,
Metering,
Pumping

Detection

Technical data or prices are subject to change without notice. Prices may vary by country and do not include taxes, customs duties or delivery.

All trademarks are the property of their respective owners. Our general terms and conditions apply: www.knauer.net/terms

Distributed by:

SONNTEK, INC.

125 Pleasant Ave.

Upper Saddle River, NJ 07458

PH: 201-236-9300 **EMAIL:** sonntek@aol.com

www.sonntek.com

© KNAUER 2018/V7857US

KNAUER

Wissenschaftliche Geräte GmbH
Hegauer Weg 38
14163 Berlin, Germany

+49 30 809727-0
+49 30 8015010 (Fax)
info@knauer.net
www.knauer.net

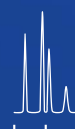

KNAUER